

Article number: 07111050000

Description: Universal joint single 0.111.050.000  
S=106 X= Bore with keyway

## Measures

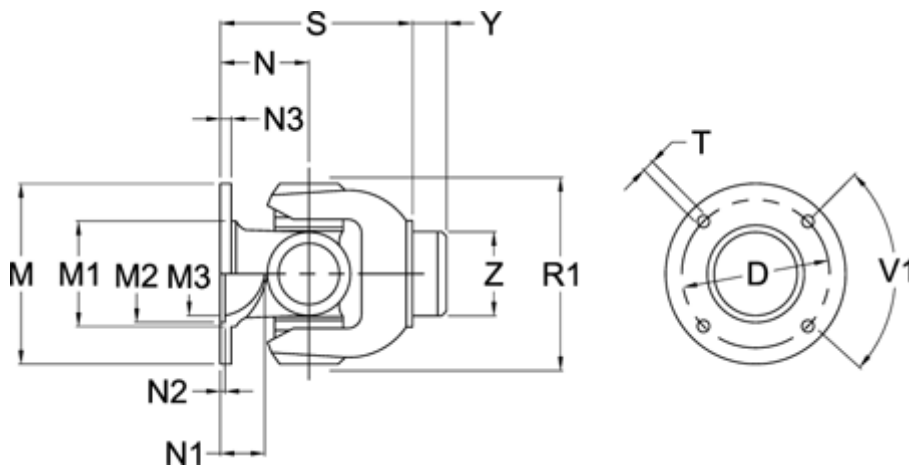

D	= 84 $\pm$ 0,1	N2	= 2,5 $\pm$ 0,5	Z = 71.25
Flange diameter M	= 100	N3	= 7	
M1	= 66	Number of Flangeholes	= 6	
M2	= 57	R1	= 98	
M3	= 52	S min	= 106	
Max. Bending Angle degrees	= 20	T	= 8 B12	
N	= 46	V1 degrees	= 60	
N1	= 20	Y	= 10	